

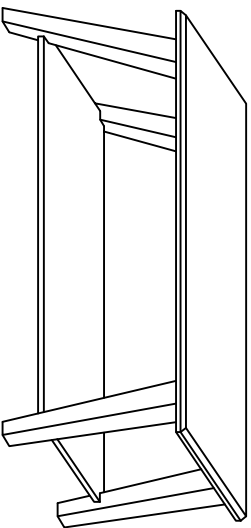

XM93-Westfield Bench
 www.thecompanystore.com
 Customer Service #: 1-800-323-8000



Thank you for purchasing the *Westfield Bench*. Page 1 lists all Hardware and Furniture Parts required to assemble this product. Please verify all components are included as you unpack the box, and place in a safe area to avoid misplacing or damaging contents. Care Instruction: Wipe with a soft, damp and clean cloth.

Tools Required

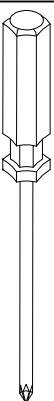

Phillips screwdriver



Allen key
(Provided)

Assembly: 2 Adults are required to safely assemble this product.

Hardware Provided

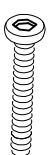

B1 8SETS-Bolts and washers

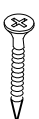

B2 8PCS-Screws



B3 8PCS-Wood dowels

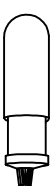

B4 1PC-Glue

Please apply a little glue B4 into the wood dowel holes when inserting wood dowels

Furniture Parts

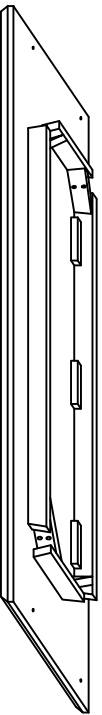

A1 1PC-Bench top



A2 2PCS-Legs

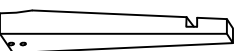

A3 2PCS-Legs

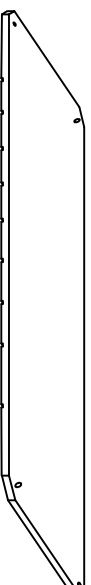

A4 1PC-Bottom shelf



A5 4PCS-Ears

Step 1

Assemble the legs A2 and A3 to the top panel A1 with bolts & washers B1 by Allen Key.
Then insert the bottom panel A4 to the grooves of legs A2 and A3, assemble the bottom panel A4 to the legs A2 and A3 with screws B2.

Note: Please don't tighten the bolts B1 in this step.

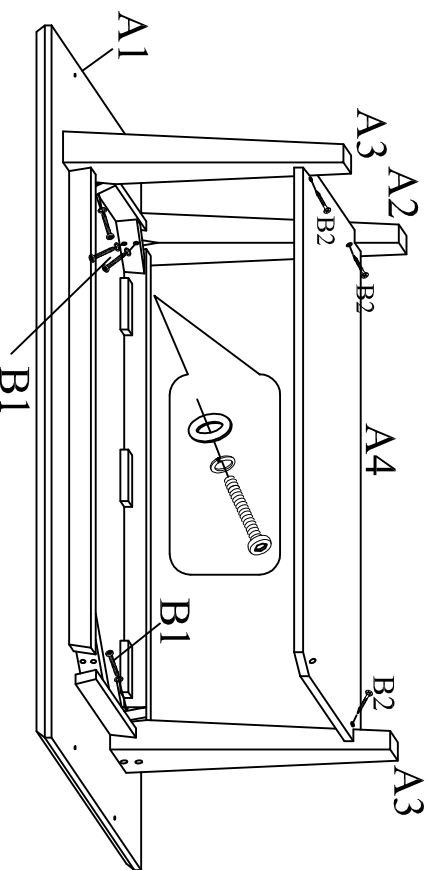

Step 3

Assemble panels A5 to the legs A2 and A3 with wood dowels B3.

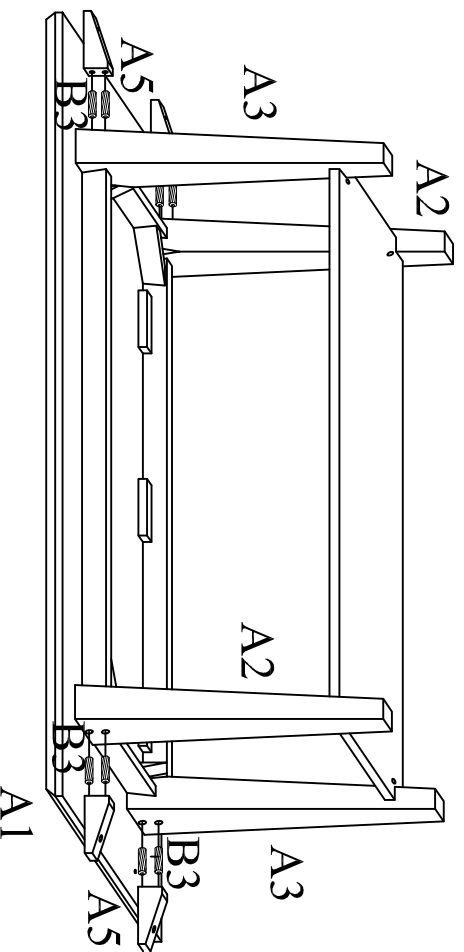

Step 2

Assemble the rest of leg A2 to the top panel A1 with bolts & washers B1 by Allen Key.
Then assemble the bottom panel A4 to the leg A2 with screws B2.

Note: Please tighten all the bolts B1 after well assemble the bottom panel A4.

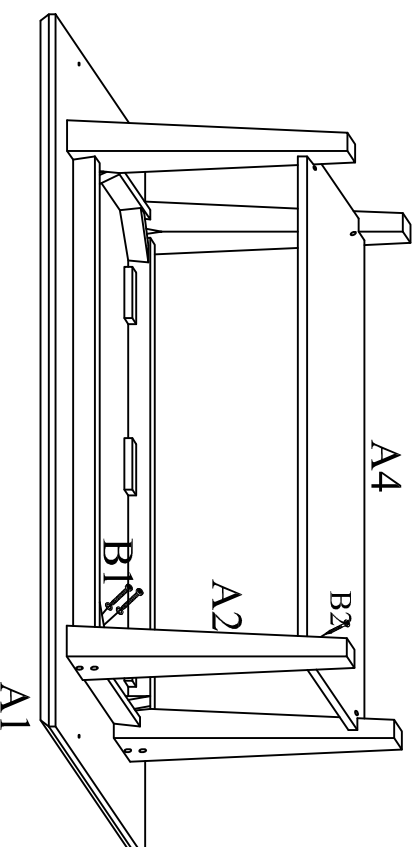

Step 4

Tighten panels A5 to the top A1 using screws B2.

Note: Maximum load is 200lbs.

